

Paddy Drying

Drying is the process that reduces grain moisture content to a safe level for storage. Drying is the most critical operation after harvesting the rice crop. Proper Drying will maintain grain quality and minimize losses.



Table of Contents

1	INTRODUCTION	4
2	PURPOSES OF DRYING	5
3	DRYING BASICS	5
3.1	Grain Moisture Content and Grain Quality	5
3.2	Equilibrium Moisture Content and Equilibrium Relative Humidity.....	8
3.2.1	Equilibrium Moisture Content	8
3.2.2	Equilibrium Relative Humidity.....	9
3.3	The Drying Process	9
3.3.1	Moisture Removal.....	9
3.3.2	Drying Rate and Temperature	10
3.3.3	Uniform Drying.....	11
3.3.4	Tempering.....	11
4	DRYING METHODS	12
4.1	Field Drying or Stacking	13
4.2	Sun Drying.....	13
4.2.1	Options for Sun Drying	14
4.2.2	Recommendations for Sun Drying.....	15
4.3	Heated Air Drying versus Low-Temperature Drying.....	17
4.4	Options for Heated Air Drying.....	19
4.4.1	Fixed-Bed Batch Dryers	20
4.4.2	Re-Circulating Batch Dryers.....	22
4.4.3	Continuous flow dryer.....	24
4.4.3.1	Conventional Continuous Flow Dryer.....	24
4.4.3.2	Flash Dryer.....	26
4.5	Options for In-Store Drying.....	26
4.6	Recommendations for Using Mechanical Dryers.....	27
5	DRYER COMPONENTS	28
5.1	Drying bin	28
5.2	Fan	28
5.3	Air Distribution System	29
5.3.1	Plenum chamber.....	29
5.3.2	Air ducts, false floors and air-sweep floors for fixed-bed drying bins	29
5.3.3	Air ducts, general recommendations	31
5.4	Heating system.....	32
5.4.1	Rice hull furnaces	33
5.4.2	Direct and Indirect Heating	34
5.4.3	Solar Drying	34
5.4.4	Safety Considerations	35

6	ACCESSORIES FOR GRAIN DRYERS	36
7	DRYING STRATEGIES	38
7.1	De-centralized On-farm Drying.....	38
7.2	Centralized drying.....	38
7.3	Two stage drying	38
8	ECONOMIC ASPECTS OF DRYING	40
8.1	Potential Economic Benefits from Drying	40
8.1	Weight Loss in Drying.....	40
8.2	Cost of Drying.....	41
8.2.1	Assumptions	41
8.2.2	Variable costs	42
8.2.3	Fixed cost	43
8.2.4	Other Economic Indicators	44
8.3	Conclusions for Economic Feasibility Studies	45
9	TROUBLESHOOTING	46
10	REFERENCES	47
11	APPENDICES	1

1 Introduction

Drying is the process that reduces grain moisture content to level where it is safe for storage. Drying is the most critical operation after harvesting a rice crop. Delays in drying, incomplete drying or ineffective drying will reduce grain quality and result in losses.

Drying and Storage are related processes and can sometimes be combined in piece of equipment (in-store drying). Storage of incompletely dried grain with a higher than acceptable moisture content will lead to failure regardless of what storage facility is used. In addition, the longer the desired grain storage period, the lower the required grain moisture content must be.



Figure 1: Sun drying pavement and re-circulating batch dryers, both installed at a rice mill

2 Purposes of Drying

At harvest time rice grain contains a lot of moisture. At high grain moisture contents there is natural respiration in the grain that causes deterioration of the rice. High moisture promotes the development of insects and molds that are harmful to the grain. High moisture in grain also lowers the germination rate of rice. Therefore, drying of rice is critical to prevent insect infestation and quality deterioration of rice grain and seed.

The purpose of drying is to reduce the moisture content of rough rice to a level safe for storage. As even short term storage of high moisture paddy rice can cause quality deterioration, it is important to dry rice grain as soon as possible after harvesting - ideally within twelve hours. The following table shows the recommended moisture content (MC) for storage of paddy grain and seed, and potential problems when the moisture content exceeds these limits:

Table 1: Moisture contents required for safe storage for different storage periods

Storage period	Required MC for safe storage	Potential problems
2 to 3 weeks	14 - 18%	Molds, discoloration, respiration loss
8 to 12 months	13% or less	Insect damage
More than 1 year	9 % or less	Loss of viability

The purpose of storage is to provide the dried grain with protection against insects, molds, rodents and birds, and to prevent moisture from re-entering the grain. Therefore, "safe" storage of paddy grain for longer periods is possible if three conditions are met:

1. Grain is dried down to 14% MC or lower (see Table 1).
2. Grain is protected from insects and rodents.
3. Grain is protected from re-wetting by surrounding air or rain.

The longer the grain needs to be stored, the lower the required moisture content of the grain. Seed stored at moisture contents higher than 14% will experience growth of molds and rapid loss of viability.

3 Drying Basics

Drying of grain involves exposing grain to ambient air with low relative humidity or to heated air. This will evaporate the moisture from the grain and then the drying air will remove the moisture from the grain. Since drying practices can have a big impact on grain or seed quality, it is important to understand some fundamentals of grain drying.

3.1 Grain Moisture Content and Grain Quality

The amount of water in rice grain is represented by the moisture content of the grain. In post-harvest handling, grain moisture content is generally stated on a wet weight basis.

Moisture content calculations		
Definitions:		Formulas
MC _{wb} =	Moisture content wet basis	[%]
MC _{db} =	Moisture content dry basis	[%]
MC _i =	Initial moisture content, w.b.	[%]
MC _f =	Final moisture content, w.b.	[%]
EMC =	Equilibrium moisture content	[%]
m _i =	Initial weight	[g]
m _f =	Final weight	[g]
MR =	Moisture ratio	
		$MC_{wb} = \frac{m_i - m_f}{m_i} * 100 \quad [1]$
		$MC_{db} = \frac{m_i - m_f}{m_f} * 100 \quad [2]$
From MC_{db} to MC_{wb}		From MC_{wb} to MC_{db}
$MC_{wb} = \frac{100 * MC_{db}}{100 + MC_{db}} \quad [3]$		$MC_{db} = \frac{100 * MC_{wb}}{100 - MC_{wb}} \quad [4]$
Weight loss during drying		
$m_f = m_i \cdot \frac{100 - MC_i}{100 - MC_f} \quad [5]$		

Often, improper drying and storage practices lead to low grain or seed quality after storage. Some problems related to incomplete or untimely drying and improper storage are:

Heat build-up in the grain: Natural respiration of stored, wet grain will generate heat, in particular when it is stored in sacks or in bulk. Heat will provide excellent growth conditions for molds and insects and thus deterioration in quality.

Mold development: Molding of grain will propagate diseases in the grain and may release toxins into the grain. Although some molds may be present in the grain at harvest time, proper drying and storage measures can reduce further propagation of these molds.

Insect infestation: Insect infestation is always a problem in stored grain in tropical climates, even if the grain is completely dried. However, the less moisture in the grain, the fewer the expected insect problems. A combination of proper drying procedures and storage practices, including storage hygiene, will keep insect infestation at acceptable levels.



Figure 2: Damaged grains

Discoloration/Yellowing: A general yellowing of the rice grain is a result of heat build-up in the paddy grain before drying. Discolored grain drastically reduces the market value of rice since whiteness is an important quality characteristic for rice consumers. Although discoloration is a complex biochemical process, it can be easily avoided by timely drying of paddy after harvest.



Figure 3: Discolored grains

Loss of germination and vigor: Moisture in grain will gradually reduce germination ability of the seed during storage. Active respiration of the grain during storage will deplete the nutrition reserves that the seed uses to germinate or sprout. Molds and diseases can also reduce the ability of the seed to germinate. The lower the moisture content of seed at the beginning of storage, the longer the seed remains viable

Loss of freshness/odor development: Deterioration of quality or aging of stored rice results

from a combination of a change in the chemical components (increase in fatty acids and decrease in sugars) and changes of rice kernel characteristics (such as kernel hardness). Heat build up in the grain (above 55°C) due to insects, molds or high humidity will often lead to a musty odor in rice. Therefore, rice stored for longer periods under adverse conditions (high grain moisture content and/or high temperatures) can develop odors, which reduce the market value of rice considerably. In particular, molds (fungi) that grow on rice can produce offensive odors due to deterioration of chemical components in the rice. If the fungi are of the mycotoxin-producing family, rice is unsafe for nourishment and might be totally unusable for food or livestock feed purposes.

Reduced head rice yield: A major cause for fissuring of rice kernels is the moisture adsorption of individual dry grains with moisture contents below 16%. This can happen either when wet grain is mixed with dry grain (in storage, in the dryer or after drying in a batch dryer with a resulting moisture gradient) or when dry grain is exposed to humid ambient air with a relative humidity higher than the equilibrium relative humidity at the corresponding grain moisture content. Fissures in rice kernels usually lead to cracking of the grain during the milling process and thus reduce the head rice recovery.

3.2 Equilibrium Moisture Content and Equilibrium Relative Humidity

3.2.1 Equilibrium Moisture Content

In storage, the final moisture content of rice depends on the temperature and relative humidity of the air that surrounds the grain. The final grain moisture content resulting from storage is called the 'equilibrium moisture content' or EMC. The following table shows the EMC of paddy under different storage conditions. The underlined & colored areas represent the desirable environmental conditions for storage of paddy for food purposes in the tropics. If grain is not protected against humidity in the air, in particular in the rainy season when the relative humidity may reach 95%-100%, grain moisture content will rise leading to quality deterioration.

Table 2: Equilibrium Moisture Contents (EMC) of paddy at different storage temperatures and RH

Relative Humidity	Storage Temperature (°Celsius)						
	22°C	24°C	28°C	32°C	36°C	40°C	44°C
50%	11.2	10.9	10.7	10.5	10.2	10.0	9.9
55%	11.7	11.5	11.2	11.0	10.8	10.6	10.4
60%	12.3	12.0	11.8	11.6	11.4	11.2	11.0
65%	12.7	12.6	12.4	12.2	12.0	11.8	11.6
70%	<u>13.5</u>	13.3	13.1	12.8	12.6	12.5	12.3
75%	14.3	<u>14.0</u>	<u>13.8</u>	13.6	13.4	13.2	13.0
77%	14.6	14.3	<u>14.1</u>	13.9	13.7	13.5	13.4
79%	14.9	14.7	14.5	14.3	<u>14.1</u>	<u>13.9</u>	13.7
81%	15.3	15.1	14.9	14.6	14.5	14.3	<u>14.1</u>
83%	15.7	15.7	15.3	15.1	14.9	14.7	14.5
85%	16.1	15.9	15.7	15.5	15.3	15.1	15.0
87%	16.6	16.4	16.2	16.0	15.8	15.6	15.5
89%	17.2	17.0	16.8	16.6	16.4	16.2	16.1
91%	17.9	17.7	17.5	17.3	17.1	16.9	16.7

For example, at 77% relative humidity and 32°C air temperature, paddy will attain 13.9% moisture content (shown in red in the table above) that is safe for storage. If at the same temperature, the relative humidity

rises to 85% or higher, grain exposed to the ambient air over time will reach an equilibrium moisture content of approximately 15.5% (shown in blue in the table above) making the grain prone to quality deterioration.

The grain moisture content of paddy stored in jute bags or clay pots will automatically increase in the rainy season to unsafe levels regardless of how well the grain was dried before storage. Therefore, for long term storage of grain or seed in tropical climates it is crucial to prevent re-wetting of grain by humid air. The lessons on storage devices and facilities give further information.

3.2.2 Equilibrium Relative Humidity

If the grain is stored in an enclosed storage environment (e.g. bag, silo, etc), the air surrounding the grain if it is well sealed is not in free contact with outside air. In this case, the relative humidity of the enclosed air will reach equilibrium with the moisture content in the grain. The final relative humidity of the enclosed air is often expressed by the 'equilibrium relative humidity'. The higher the grain moisture content of the stored grain, the higher the equilibrium relative humidity, and the higher the chances of mold development or loss of germination. In general, an equilibrium relative humidity inside the storage of 65% or less is considered a safe prevention against the development of molds.

3.3 The Drying Process

3.3.1 Moisture Removal

In paddy grain, moisture is present at two places: at the surface of the grain, *surface moisture* and in the kernel, *internal moisture*. Surface moisture will readily evaporate when grain is exposed to hot air. Internal moisture evaporates much slower because it first has to move from the kernel to the outside surface. As a result, surface moisture and internal moisture evaporate at a different rate. This difference results in a different *drying rate*; the rate at which grain moisture content declines during the drying process. The drying rate is normally expressed in %/hr. Typical drying rates of grain dryers are in the 0.5%/hr to 1%/hr range.

A drying curve, as illustrated in the figure below, shows how the grain moisture content changes over time and how grain temperature changes. As can be seen in the chart, the drying rate is not constant but changes over time. The temperature of the grain equally changes over time.

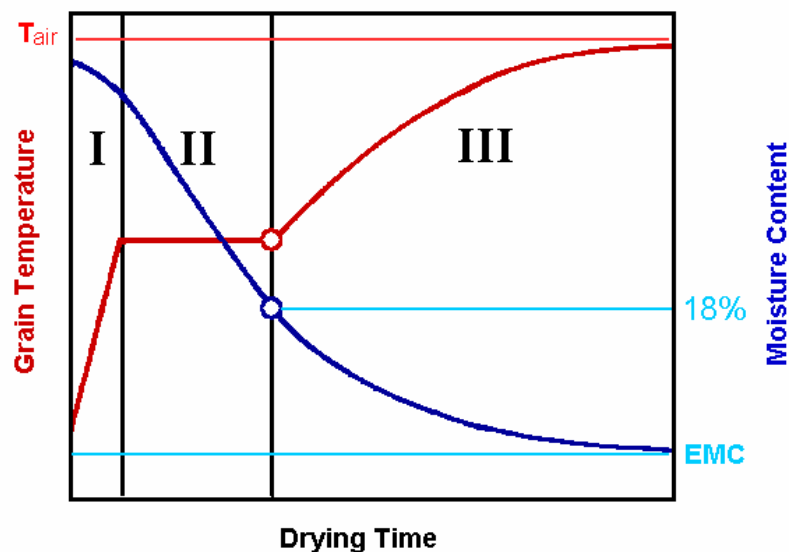

Figure 4: Theoretical drying curves (grain temperature red and moisture content blue) with different drying periods

There are three different periods which will occur consecutively in time:

- I. Preheating period (drying rate is slowly increasing): When wet grain is exposed to hot air, initially only a very slight change in MC is observed. This happens because all the heat provided in the drying air is used to heat up the grain to the drying air temperature.
- II. Constant-rate period (drying rate is constant in time): Once the grain is at the drying temperature, water starts to evaporate from the surface of the grain. During this period, all the heat from the drying air is used to evaporate surface moisture and the amount of moisture removed from the grain is constant in time. It is therefore called the constant-rate period. During this period, grain temperature is constant as well.
- III. Falling-rate period (drying rate declines over time): As time passes, it takes more time for internal moisture to appear at the surface, and evaporation of water is no longer constant in time. As a result, drying rate will decline, and some of the heat from the drying air will heat up the grain. For paddy grain, the falling-rate period typically occurs at around 18% grain moisture content.

By using the 18% MC and the drying curve as a guideline, a few recommendations can be made regarding grain drying procedures. These recommendations can be used regardless whether grain is dried in the sun or by using artificial grain dryers.

3.3.2 Drying Rate and Temperature

Above 18% MC the grain drying rate can be increased (that is, drying will occur faster) by providing a higher temperature without major changes in grain temperature. Below 18% MC increase in drying air temperature will not only increase the drying rate but will increase grain temperatures and potentially damage the grain. Therefore, higher drying air temperatures can be used to dry grain quickly down to 18% MC (to remove "surface moisture") but lower temperatures should be used to remove internal moisture from the grain.

For seed purposes, drying air temperatures should never exceed 43°C, regardless of the MC, to avoid overheating of the grain which kills the germ. Exposing paddy to 60°C for one hour can reduce the seed

germination rate from 95% to 30%. Two hours at 60°C can reduce the germination rate to 5%.

3.3.3 Uniform Drying

During the drying process there is always variability in MC of individual grains. Especially in fixed-bed dryers the grains at the air inlet dry faster than at the air outlet resulting in a moisture gradient in the grain bulk at the end of the drying process. For production of good quality grain or seed, this variability should be kept as low as possible. Frequent stirring in sun drying, grain turning in fixed bed dryers or circulation in re-circulating batch dryers will improve uniformity of drying, minimize the re-wetting of dried grains and thus maintain grain quality.

3.3.4 Tempering

When the drying of grain is temporarily stopped the moisture within the grain equalizes due to diffusion. When drying is restarted, the drying rate becomes higher compared to continuous drying. The process of stopping intermittently is called tempering. In addition during tempering the moisture differences between grains equalize. Tempering therefore also ensures that moisture gradients in the grain bulk that develop during drying in certain dryer types are minimized.

To maintain grain quality, including a tempering period is recommended to allow for redistribution of internal moisture in the grain. In modern re-circulating grain dryers, grain is not dried continuously but goes through a cycle of drying followed by tempering. This improves drying rates, grain quality and reduces energy costs.

4 Drying Methods

There are many different drying methods used for drying rice. They involve various drying technologies of different scale and complexity. There is no ideal dryer for drying rice since each drying method has its own inherent advantages and disadvantages.

Table 3: Overview on different drying methods and technologies

Method	Crop Flow	Drying Technology	Characterization
Field drying		Piles, racks	☹ Rapid quality reduction
Sun drying	Batch	Drying pavements or mats	☺ Cheap ☹ Labor intensive ☹ Typically poor milling quality
Heated air drying	Batch	Fixed bed dryer	☺ Inexpensive, small scale operation possible ☺ Local construction from various materials ☺ Operation with unskilled labor ☹ Moisture gradient ☹ Labor intensive
		Re-circulating batch dryer	☺ Mixing of grain ☺ Large capacity range ☺ Good quality ☹ Skilled laborers required ☹ Medium capital investment ☹ After-sales service requirement ☹ Wear of moving components
	Continuous	Continuous flow dryer	☺ Large capacity ☺ Economics of scale ☹ High capital investment ☹ Not feasible for small batches of different varieties ☹ Complicated
In-Store Drying	Batch	Storage bin with aeration components and pre-heater for adverse weather and nighttime	☺ Excellent grain quality ☺ Large capacity range ☹ Pre-drying of high moisture grain ☹ Risk of spoilage during power failure

4.1 Field Drying or Stacking

In many traditional harvesting systems farmers leave their harvested rice in the field for extended time because they are either waiting for the thresher or because they want to pre-dry the paddy. In this practice, often referred to as field drying, the rice plants are often stacked in piles with the panicles inside to protect them from rain, birds and rodents, a practice that can lead to massive heat build up inside the stacks. As a result molds grow quickly and infest the grains and discoloration usually develops within the first day of field drying. Another unwanted effect is that the relatively dry grains often absorb water from the wetter straw, which leads to fissuring of the dryer grains and thus reduces the potential head rice recovery.

It is impossible to produce good quality grains with field drying practices and field drying should therefore be avoided.



Figure 5: Farmers stacking harvested rice crop for temporary field drying (Source: G. Hettel)

4.2 Sun Drying

Sun drying is the traditional method for drying and is still preferred in Asia because of its low cost compared to mechanical drying. It requires little investment and is CO₂ neutral since it uses the sun as heat source. Sun drying has some limitations:

- It is not possible during rain and at night.
- Any delay leads to excess respiration and fungal growth causing losses and yellowing.
- It is labor intensive and has limited capacity.
- Temperature control is difficult. Overheating or re-wetting of grains can result in low milling quality as a result of cracks developing in the kernels.

4.2.1 Options for Sun Drying

Panicle drying

Drying of paddy grains that are still attached to the panicles is a traditional method for drying small amounts of paddy. The panicles are harvested with a small knife, bound together and carried to the drying location. The dried panicles are then stored in farmers' houses, for example by hanging them under the roof for protection from rodents.

For drying the tied bundles are placed on pavements or mats or hung from frames. The grains inside the panicle dry slower than the grains that are exposed directly to the sun. Turning of the panicles improves the drying process but "mixing" of the grains is not possible.



Figure 6: Panicles drying on road

Drying on Nets, Mats or Canvas



Figure 7: Sun drying on woven mat

Small to medium amounts of paddy can be placed on nets, mats or plastic sheets (canvas). Except for nets (which allow dirt to enter the grain) this is the most hygienic method. Paddy dried on mats or canvas does not contain stones and other dirt, often found in paddy that was dried on roads. When drying is finished or in case of sudden rainfalls the grains can be collected quickly by lifting the mats at the edges. Mixing can also be done easily that way.

Drying of high moisture grain might initially be a bit faster on nets because the water can also migrate to the bottom instead of condensing on a waterproof plastic sheet. But at lower moisture contents there is the danger of re-wetting of the bottom grains from soil moisture when nets are used.

Small capital is required for the mats but often they have multiple uses in farmers households so that the cost is not only allocated to the drying operation.

Pavement Drying

Better-off farmers, grain collectors, traders and millers often dry their paddy on pavements, either specifically constructed for drying or also used for other purposes (e.g. as basketball court).

Sun drying pavements have the advantage of high capacity and thus economics of scale and the drying operation can be partially mechanized. Usually manual tools are used for mixing and grain collection but larger mills often use two or four wheel tractors for this purpose.

There is a significant capital requirements for the pavement and if cleanliness is not observed pollution with stones and dirt is common.



Figure 8: Collecting grain after sun drying on pavement

Technology Options to Improve Sun Drying

Sundrying is going to be practiced as long as there is a market for low quality paddy, because it is the cheapest drying method. As long as there is no quality-incentive for better quality rice it will be the preferred method whenever the weather allows. Traditional sundrying can be improved using simple tools and monitoring equipment.



Figure 9: Tools for improved sun drying

In some areas pavements with elevations are used for reducing the effort in temporarily collecting the grain during rain. During rain or at night the paddy is moved to the elevations and covered with plastic sheets. Rain water flows down and drains in the submersions.

Tools or machines for mixing and collecting grains make labor more efficient. Essential tools for maintaining the quality of paddy are moisture meters and thermometers for monitoring temperature and finishing the drying process when the desired MC is reached.

4.2.2 Recommendations for Sun Drying

If sun drying is managed properly it can produce good quality grain. General guidelines for proper sun drying are:

Layer Thickness

Spread the grains in thin layers, ideally 2-4 cm.

Too thin layers tend to heat up very quickly with negative effect on the head rice recovery. If layers are too thick a large moisture gradient develops with dry grains on the top and wet grains on the bottom, which re-adsorbs moisture after mixing, thus resulting in cracked grains. The optimum layer thickness is somewhere between 2-4 cm.

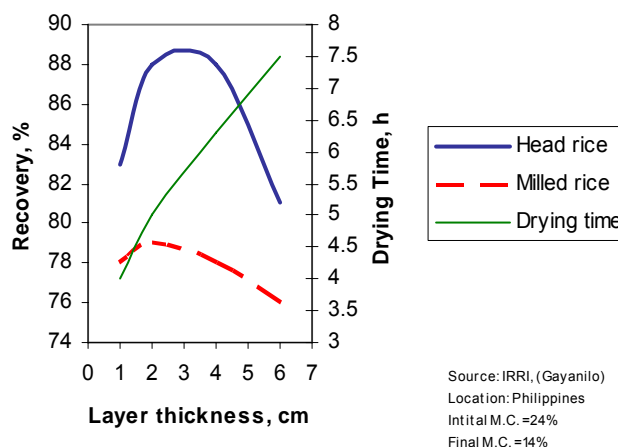

Figure 10: Effect of layer thickness during sun drying on head rice recovery, milled rice recovery and drying time.

Mixing

During good weather conditions mixing or turning the grain is the most important activity for maintaining good quality

Turn or stir the grain at least once per hour, better every 30 minutes to achieve uniform MC. Variation in MC within the grain causes re-wetting and subsequent grain cracking of drier kernels.

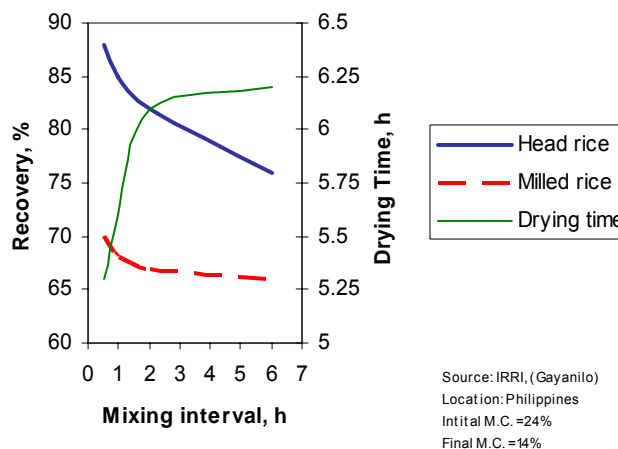

Figure 11: Effect of the mixing interval during sun drying on head rice recovery, milling recovery and drying time

Protection

Additional measures need to be taken for maintaining optimum quality during sun drying including:

- On hot days the grain temperature can rise above 50-60°C. If that is the case cover the grain at mid-day to prevent over-heating;
- Cover the grain immediately if it starts raining. Re-wetting of grain causes fissured grains and high grain breakage during milling;

- Prevent contamination of grain with other materials and keep animals off the grain; and
- Monitor grain moisture content and grain temperature.

Additional Factors Affecting the Drying Rate

Besides layer depth and mixing interval the drying rate of sun drying depends on other factors which are usually out of control of the operator:

- Temperature and humidity of ambient air: The rate at which rice dries is affected significantly by the temperature and humidity of the air that moves over or through the grain. For this reason, in most tropical, humid climates sun drying is only successful during a few hours in the mid-day.
- Initial moisture content of grain: Wet grains dry at a higher drying rate than comparatively dry grains.
- Air velocity: Natural convection is usually not enough to transport large amounts of evaporated moisture away from the grain. Therefore, drying rates of sun drying are higher on windy days compared to days without wind.

Other Issues

Often public roads are used for sundrying (highway drying). This pollutes the grain, hinders traffic and can cause accidents and therefore in different countries efforts are underway to abolish drying on public roads.

4.3 Heated Air Drying versus Low-Temperature Drying

Heated air drying and low-temperature drying (also sometimes referred to as near-ambient drying) employ two fundamentally different drying principles. Both have their own advantages and disadvantages and are sometimes used in combination (see Section 7.3 Two stage drying). Heated air drying employs high temperatures for rapid drying and the drying process is terminated when the average MC reaches the desired final MC. In low temperature drying the objective is to control the RH of the drying air so that all grain layers in the deep bed reach equilibrium moisture content (see also Section 3.2.1). Table 4 shows the major differences.

Table 4: Difference between Heated Air Drying and Low-Temperature Drying under humid tropical conditions (both fixed bed batch dryers)

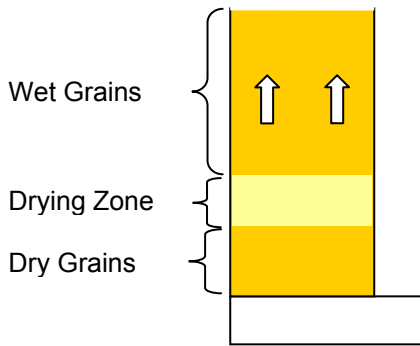
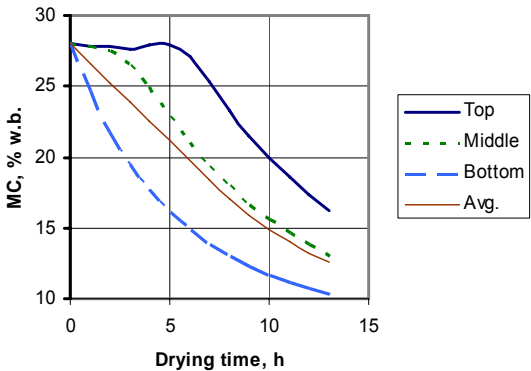
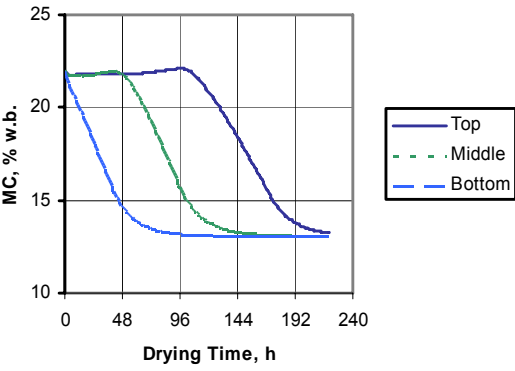
	Heated Air Drying (Shallow Bed)	Low-temperature Drying (Deep Bed)
Drying process		
MC at different layer depths		
Process Parameters	<p>Drying air temperature: 43°C Air velocity: 0.15-0.25 m/s Airflow rate per t grain: >0.7 m³/s Power requirement: 1.5-2.5kW/t grain Layer depth: < 40 cm Drying time: 6-12 h Initial MC: up to 30%+</p> <p><u>Advantages:</u></p> <ul style="list-style-type: none"> • Simple management • Fast drying • Affordable • Low level of integration <p><u>Disadvantages:</u></p> <ul style="list-style-type: none"> • 3-4% moisture gradient in final product, requires mixing or reduced layer depth • Reduction in milling yield • Danger of killing seeds 	<p>Drying air temperature: Δ T = 0-6 °K Air velocity: 0.1 m/s Airflow rate per t grain: >0.05-0.4 m³/s Power requirement: 0.05-0.15 kW/t grain Layer depth: < 2 m Drying time: days to weeks Initial MC: 18% (28%)</p> <p><u>Advantages:</u></p> <ul style="list-style-type: none"> • Very energy efficient • Bins can be filled at harvest rate • Maintains grain quality optimally • Drying in storage structures <p><u>Disadvantages:</u></p> <ul style="list-style-type: none"> • Increased risk with poor power supplies • Requires bulk handling system (high level of integration in postharvest system) • Long drying time

In heated-air fixed-bed batch dryers the hot drying air enters the grain bulk at the inlet, moves through the

grain while absorbing water and exits the grain bulk at the outlet. The grain dries faster at the inlet because in there the drying air has the highest water absorbing capacity. Because of the shallow bed and relatively high airflow rates drying occurs in all layers of the grain bulk, but fastest at the inlet and slowest at the outlet (see drying curves in Table 4). As a result a moisture gradient develops, which is still present at the end of drying. The drying process is stopped when the average moisture content of the grain (drying air inlet and drying air outlet) is equal with the desired final moisture content. When the grain is unloaded and filled in bags the individual grains equilibrate meaning that wetter grains release water which the dryer grains adsorb so that after some time all grains have the same MC. The re-wetting of the dryer grains, however, leads to fissuring causing the grains to break in the milling process. This explains why the milling recoveries and head rice recoveries of grains dried in fixed bed batch dryers is not optimal. One way to minimize the moisture gradient during drying is to mix the grains in the drying bin after around 60-80% of the drying time has passed.

In low-temperature drying the objective of the dryer management is to keep the RH of the drying air at the equilibrium relative humidity (ERH, see Section 3.2.2) corresponding to the desired final moisture content of the grain. The effect of the temperature is minimal compared to the RH (Table 2). If for example a final MC of 14% is desired one should target an RH of the drying air of around 75%. In practice the ambient air can be used at daytime in the dry season. At night and during the rainy season slightly pre-heating of the ambient air by 3-6°K is sufficient to drop the RH to appropriate levels

The drying air enters the grain bulk at the inlet and while moving through the grain bulk it dries the wet grains until the air is saturated. While absorbing the water the air cools down by a few degrees. On its further way through the grain bulk the air cannot absorb more water, since it is already saturated, but it picks up the heat created by respiration, insects and fungal growth and thus prevents heating up of the still wet grain section. A drying front of several centimeters depth develops and slowly moves towards the outlet leaving dried grain behind. After the drying front leaves the grain bulk the drying process is finished. Depending on initial moisture content, airflow rate, grain bulk depth and drying air properties this can take from 5 days to several weeks

The low temperature drying process is very gentle and produces excellent quality while maintaining high germination rates. Since very low air velocities are used (0.1 m/s) and pre-heating of the drying air is not always needed the specific energy requirement is lowest among all drying systems. Low-temperature drying is usually recommended as second stage drying for paddy with MC not larger than 18%. Research at IRRI has shown that with careful dryer management even freshly harvested grain with MC of 28% can be dried safely in single stage low-temperature dryers if bulk depth is limited to 2m and the air velocity is at least 0.1 m/s. However, in most developing countries, where power failures are still common, it constitutes a significant risk to put high moisture grains in bulk without a backup electricity supply to run the fans.

4.4 Options for Heated Air Drying

Unlike sun drying, heated air drying or mechanical drying has the advantage that suitable drying air conditions can be set, and that drying can be carried out any time of the day or night. Use of mechanical drying may also reduce the labor costs, especially if some form of mechanical turning or stirring of grain is practiced, as in the case of re-circulating dryers. In general, mechanically dried grain will produce better quality rice compared to sun drying. Mechanical drying will lead to more uniform drying of grain and higher milling yield and head rice recovery. Since rice quality is becoming more important to rice consumers, medium-sized grain dryers have become a common sight throughout Asia. For production of premium quality rice or seed, mechanical drying with heated air dryers is highly recommended. Grain re-circulation allows for uniformly dried grain and automatic drying air temperature control will maximize the drying rate and at the same time reduce over-heating or over-drying. The most common way of characterizing heated air drying systems is through the description of the way how the grain is being held in or flows through the system. Here we differentiate between fixed bed batch dryers, re-circulation batch dryers and continuous flow dryers (Figure 12).

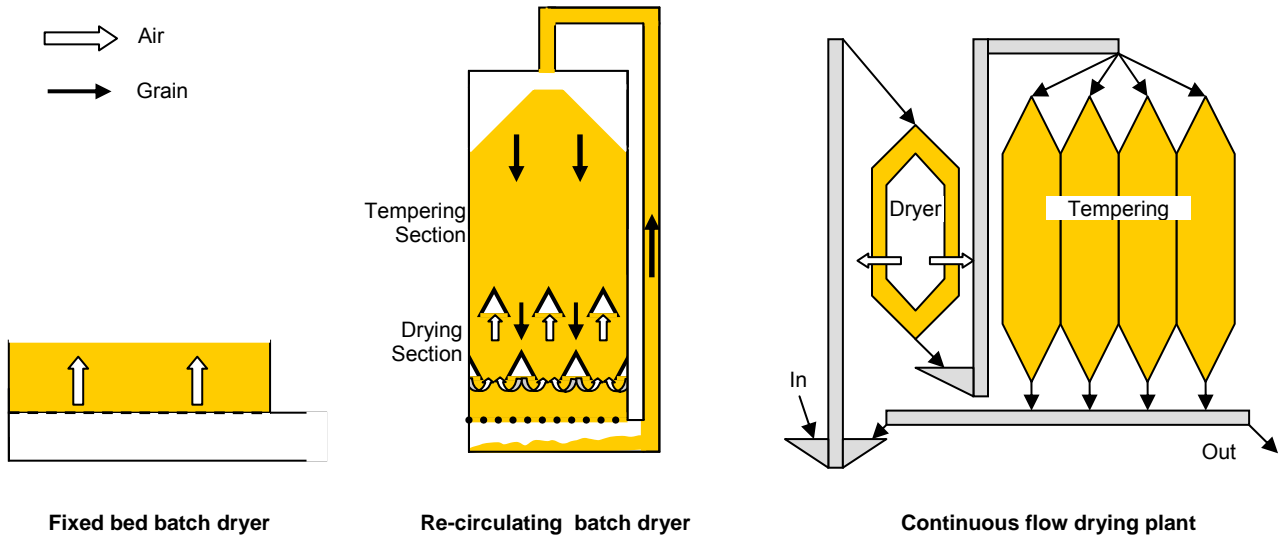

Figure 12: Dryer classification according to crop holding / crop flow

The most common types of grain dryers in Asia are the fixed bed dryer and the re-circulating batch dryer. They are both batch-fed dryers meaning that a certain quantity of grain is loaded and dried before the dryer is unloaded and a new batch can be dried.

4.4.1 Fixed-Bed Batch Dryers

Fixed bed batch dryers usually have rectangular bins with plenum chamber underneath (flat bed dryer, box dryer, inclined bed dryer) or circular bins with central duct (Vietnamese low-cost dryer).

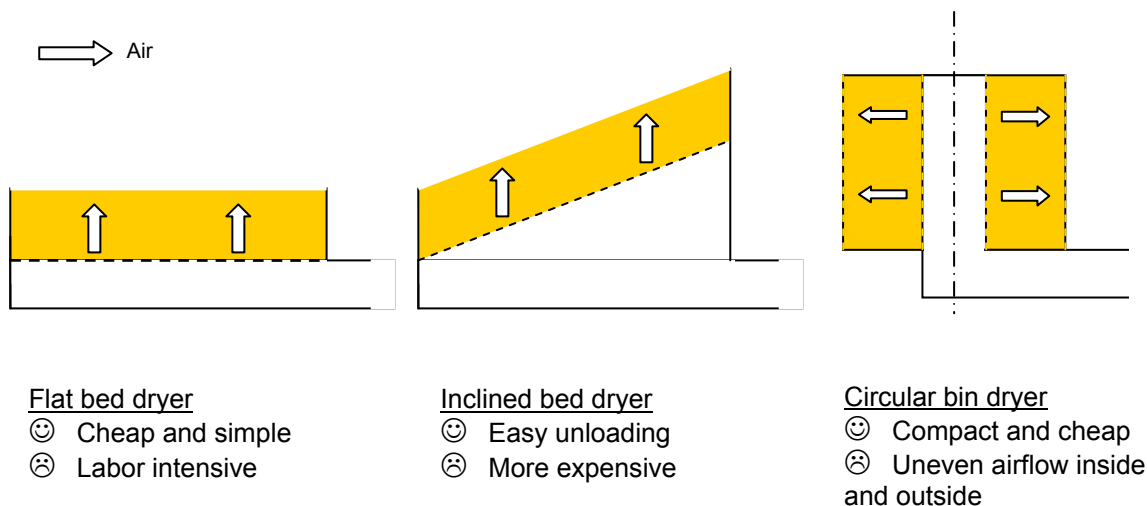

Figure 13: Bed configuration of fixed bed batch dryers

The most common fixed bed dryers are flat bed dryers which have a very simple design. Grain is laid out on a perforated screen, and dried by forcing air from below. The air fan that provides the drying air is

usually a simple axial flow fan that is powered by a diesel engine or by an electric motor. A kerosene burner or a biomass stove provides drying heat. The capacity of the dryer varies from one to ten tons. Generally the drying floor is flat although dryers with reclining sections (to facilitate unloading) or vibrating sections (to facilitate stirring) exist as well. The height of the layer is usually 40 cm. The most common smaller dryers have a capacity of one to three tons per day with drying times of six to twelve hours. For drying of paddy in tropical areas, an air temperature of 40-45°C is normally used with a heater capable of raising the air temperature 10-15° C above ambient. An air velocity 0.15-0.25m/s is required and typical fan power requirements are 1.5-2.5 kW /ton of paddy. The efficiency of these dryers as well as the head rice recovery is improved by stirring the grain during drying.



Figure 14: Kerosene fired tilted-bed dryer for easy unloading (left), drying bin with perforated false floor (right)

Other fixed bed dryers have a cylindrical duct made out of porous materials with a central duct for drying air delivery. These models save floor area and small scale units can be made out of very cheap materials such as woven bamboo mats thus keeping the dryer affordable for small farmers. However, an inherent problem of this dryer type lies in its circular design because the inner layers of the grain bulk contain less grain than the outer layers. Air velocities and thus drying potential are therefore larger close to the center of the dryer where the drying air enters the grain bulk and the air velocity decreases on its radial path through the grain. At the outlet, the drying rate which is already lower because of adsorbed water is further reduced by the lower specific air volume. This leads to even higher moisture gradients compared to flat bed dryers. Circular bin dryers made out of locally available materials, however, offer very affordable solutions to farm level drying, especially when they are used for ambient air drying with low temperatures where the moisture gradient is minimized.

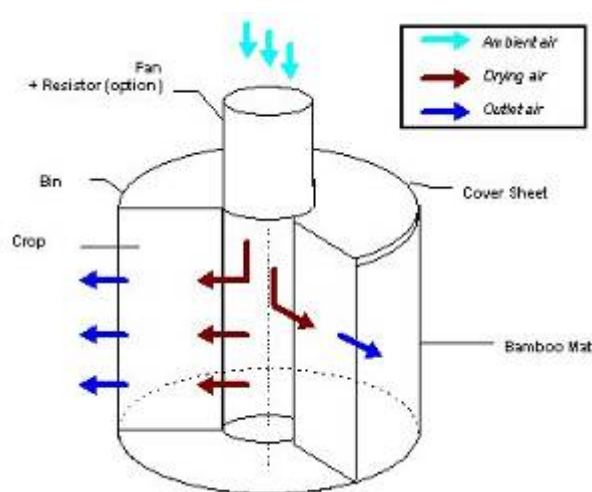

Figure 15: Vietnamese low-cost dryer with circular drying bin made from locally available materials,

schematic diagram (left) and dryer in operation on a Vietnamese farm (right)

To reduce the moisture gradient that develops during drying and to eliminate the need for mixing, some manufacturers have introduced devices for reversing the airflow in some fixed bed dryer models. This reduces the moisture gradient and thus improves the quality of the dried paddy but it adds to costs. Compared to the more complicated re-circulating batch dryers this is still a feasible solution where simple design is needed and operator skills are low.

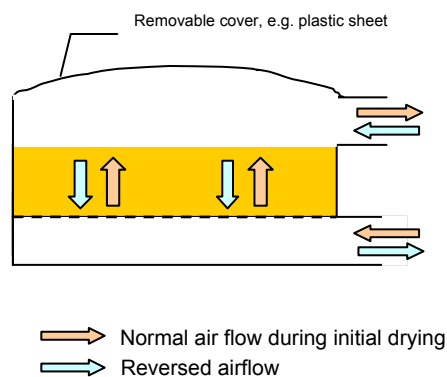

Figure 16: Principle (left) and example of a mobile reversible-flow batch dryer (right)

4.4.2 Re-Circulating Batch Dryers

Re-circulating batch dryers have been used for a long time in developed countries. In many Asian countries re-circulating batch dryers are increasingly being used by the private sector for producing better quality grain and for handling large amounts in the peak season safely.



Figure 17: A row of re-circulating batch dryers in a Philippine rice mill

The dryer generally has a drying section and a tempering section, and grain circulates through these sections in order to alternate drying and tempering. At the same time the grains are mixed which results in minimal moisture variation in the dried grains. In general, burners are separated from the fan and the fan draws air through the dryer and the burner that is mounted on the opposite side of the dryer. Re-circulation of grain is done by a belt or auger for unloading and bucket elevator for vertical transport of the grain.

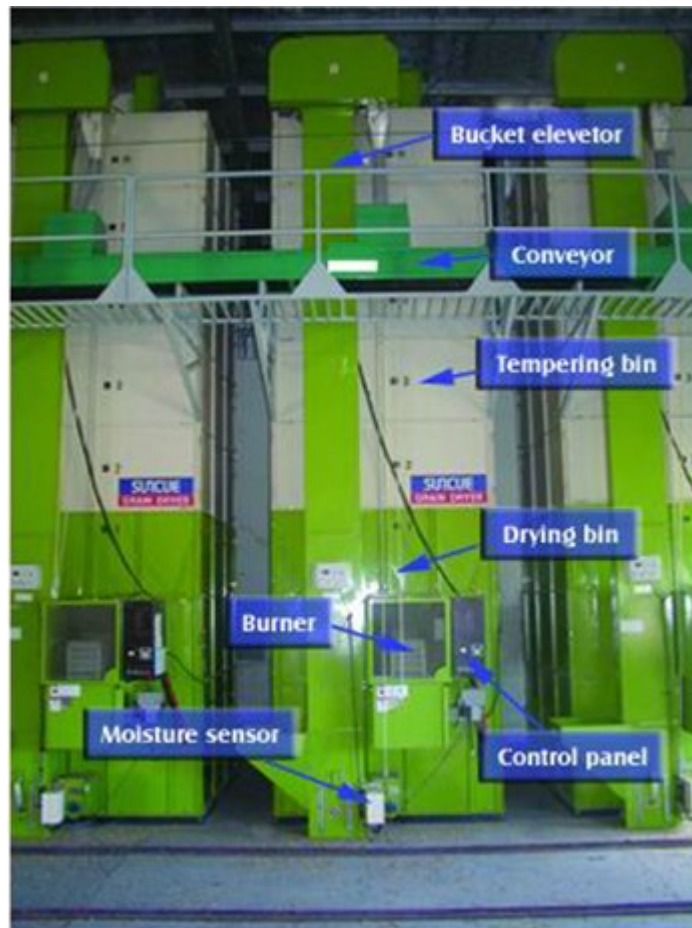

Figure 18: Components of a re-circulating batch dryer

The main advantages of the re-circulating dryer are:

- Its size and shape occupies only very limited floor space therefore it can easily be placed inside a grain store or warehouse;
- The continuous mixing of the grain during the drying operation results in a very low moisture content variation;
- During the circulation process the grain is tempered when it passes through sections of the dryer where it is not exposed to the hot drying air; and
- Automatic controls with automatic shutoff make the dryer virtually fully automatic.

However, the loading, unloading and circulation of grain create dust which needs to be collected in a collection system. In addition, it is recommended to pre-clean the grain prior to loading and drying. As with the flatbed dryer, re-circulating dryers come in a variety of capacities, from 2 tons (for seed production stations) up to 20 tons (for cooperative drying stations).

Depending on the flow of the drying air relative to the flow of the grain re-circulating batch dryers can be classified as cross flow or mixed flow re-circulating batch dryers.

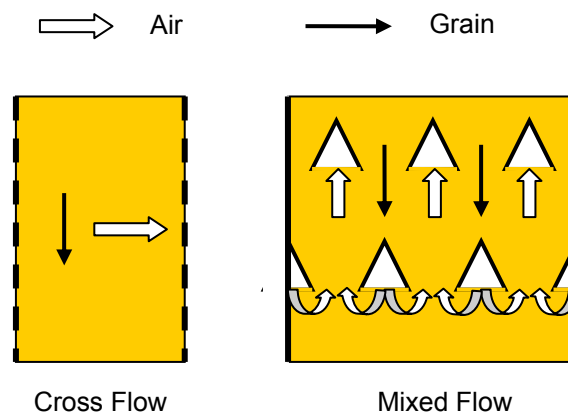

Figure 19: Air flow relative to grain flow in the drying section of re-circulating batch dryers

In cross flow dryers the grains are not mixed while they are passing the drying section and being exposed to the hot drying air. This means that a moisture gradient develops in the drying section of the dryer. In the recirculation and tempering process this gradient is reduced because the wet and dry grains are mixed while they are being conveyed and subsequently moisture transfer happens from the wetter to the dryer grains. While this process is not optimal it still produces much better quality than a fixed bed dryer because the moisture gradients are much smaller.

Mixed flow drying sections can be considered the optimal solution for producing top quality rice. Meanwhile almost all re-circulating dryers sold in Europe utilize the mixed flow principle. In a mixed flow dryer the grain is permanently being mixed while it passes the drying section and thus a moisture gradient cannot develop. Mixed flow drying sections, however, have limitations when the crop is very wet and has a lot of foreign materials. Because there are more components inside the drying section clogging can happen more easily than in cross-flow drying sections.

4.4.3 Continuous flow dryer

4.4.3.1 Conventional Continuous Flow Dryer

Although not very common in Southeast Asia continuous flow dryers are used by some larger milling enterprises that handle large volumes of wet paddy. Conventional continuous flow dryers usually consist of either mixing or non-mixing columnar dryers with different systems of airflow with respect to the grain (Figure 20).

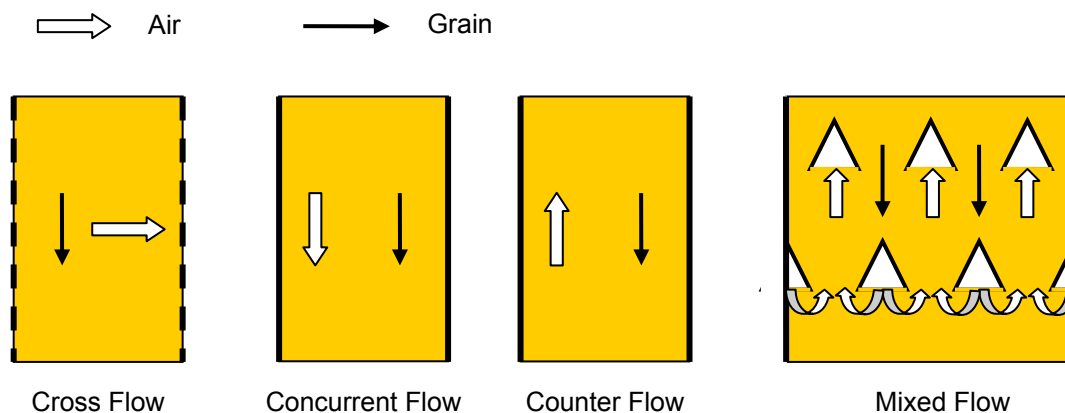

Figure 20: Air flow relative to grain flow in the drying section of continuous dryers

Cross flow dryers are of *simple design*. In the drying zone the grain moves downwards between two perforated metal sheets while the air moves horizontally through the grains. Since the grain is not mixed moisture gradients develop across the bed. They are also less susceptible to clogging than mixed flow dryers.

In concurrent flow dryers the air moves in the same direction as the grain. This has the advantage that the air with the highest drying potential is in contact with the wettest grains. Higher air temperatures can be used for a *fast drying* process. Drying is rapid in the upper layers and slower in the lower layers, which suits the drying characteristics of paddy.

In counter flow dryers the air moves upwards against the movement of the grain. This system is very *energy efficient* since the drying air continues to adsorb moisture on its way through the increasingly wet grain until the air outlet.

Mixed flow dryers produce the *best quality* grains because of the continuous mixing effect. The inlet and outlet ducts can be placed in alternating pattern so that both concurrent flow and counter flow of the air can be achieved in one dryer.

A continuous flow dryer cannot be used as a stand alone machine but needs to be integrated in a larger system consisting of the dryer, several tempering bins and conveying equipment (Figure 12). It is not possible to dry the paddy in a continuous flow dryer from typical MC content down to levels for safe storage in one single pass. Typical drying MC reduction rates per pass are around 2%. One pass lasts 15-30 minutes at around 70°C drying air temperature. Higher rates could be achieved by increasing either the drying air temperature or the retention time but both would negatively affect grain quality because of increased cracking. Continuous flow drying systems are therefore operated as multi-pass systems where the grain is moved to tempering bins for around 24 hours after each pass until the desired MC is reached (see also Section 3.3.4 Tempering). Sometimes the tempering bins are equipped with aeration facilities to cool down the grain with some additional low-temperature drying effect. Actual residence time in the continuous flow dryer in a multi pass system is 2-3 hours for a 10% reduction of moisture and is thus below that of a re-circulating batch dryer.

Continuous flow dryer operation needs to be carefully planned and requires good management in order to fully utilize the expensive equipment. In addition it requires continuous input of wet grains at a steady rate. The small scale farms, multitude of varieties, low labor and management skills and high capital investment needs are some of the reasons why continuous flow dryers are for the time being not feasible in most Asian countries.

4.4.3.2 Flash Dryer

Special continuous dryer types, which are used as first stage dryers in two-stage drying systems, are the rotary drum dryers in the Philippines and the fluidized bed dryers which were successfully commercialized in Thailand in the nineties. Both types use extremely high temperatures (up to 110-120°C) for rapid removal of the surface moisture and can only dry down to 18% MC without damaging the grains (see also Section 7.3 Two stage drying). While the rotary drum dryers were mainly disseminated through government programs the fluidized bed dryers in Thailand were accepted by the private sector and are well integrated in combination drying systems that include either large scale in-store drying facilities with several hundred tons capacity or mixed flow heated air dryers for second stage drying to storage MC.

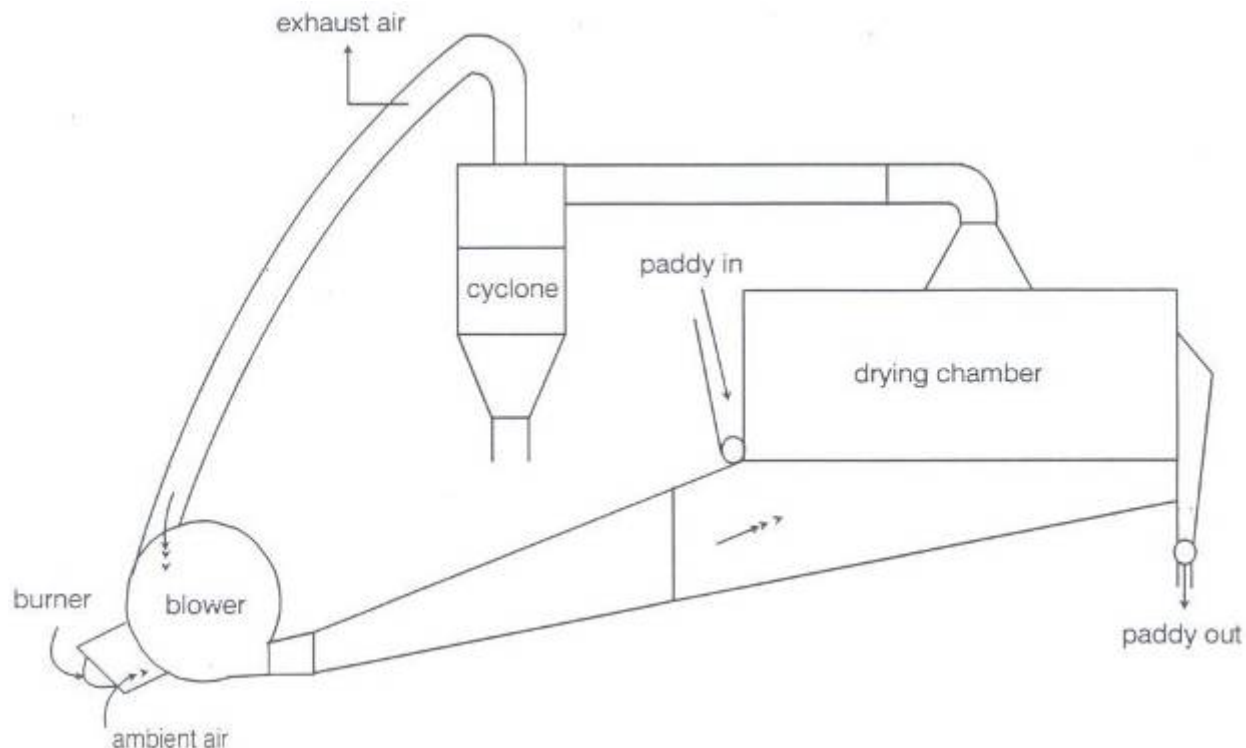

Figure 21: Principle of a Thai fluidized bed dryer for first-stage drying down to 18% MC (Soponronnarit, 1996)

The fluidized bed dryer consists of a drying chamber with an air speed of around 2.3 m/s, a bed thickness of 10 cm in which the grain is exposed to the drying air for 10-15 minutes. Capacities of commercial units range from 1-10 t/h. A diesel burner or a rice hull furnace is used as heat source and a system for recycling 50-70% of the drying air is provided to improve energy efficiency. Typically head rice yields are reported to be up to 5% reduced compared to samples dried at ambient air while the effect on whiteness is minimal [5].

4.5 Options for In-Store Drying

In store drying or near ambient air drying uses a different drying principle than heated air dryers. In store-dryers were installed in large numbers on Korean farms for farm level drying. In recent years in-store drying became popular in Thailand as the second stage drying method for two-stage drying (see Section 7.3). In-store drying utilizes the drying potential of the ambient air which is blown through the grain bulk in the storage bin. The objective of the dryer management is to keep the relative humidity of the drying air close to the equilibrium relative humidity of the final moisture content. The grain therefore only dries until it

reaches the equilibrium moisture content and thus over drying of the bottom layer is minimized. The drying process is slow and can take several days to weeks depending on the depth of the grain bulk (2-4m depending on the initial moisture content). Low air velocities (around 0.1m/s for very wet grain) are used and thus energy requirement is kept to a minimum.



Figure 22: Korean low-temperature in-bin drying and storage system (IBDS) at farm level (left), aeration ducts in a large storage system (right)

In-store drying is the ideal second stage drying method because the slow and gentle drying process maintains the grain quality and low energy requirements leads to low energy cost. In addition, if moisture contents increase in storage, the storage facilities can easily be aerated again.

One-stage in-store drying from harvest moisture content as high as 30% down to a level save for storage has also been proven to be technically feasible as long as the air velocity is kept constant at 0.1 m/s and grain depth is limited to 2 m. There is, however, the risk of rapid grain deterioration in case of power failure with high initial moisture contents. [1]

4.6 Recommendations for Using Mechanical Dryers

General recommendations for using mechanical grain dryers:

- When installing a dryer select the model carefully considering the technical requirements, economical feasibility and the volumes of paddy to be dried.
- Get familiar with the operation of the dryer and try to understand the drying process. Insist on proper training to be provided by the manufacturer.
- Before loading the dryer, clean the grain by removing fines and green, immature grains and materials other than grain. Fines reduce the airflow through rice causing increased drying time and wet spots. Green, immature grains and straw extend drying time and increased energy consumption.
- In the dryer, do not mix dry with wet paddy. The drying air gains moisture as it passes through the dryer and may cause the dry grains to fissure.
- Monitor the drying air temperature, especially when drying seeds, to avoid heat stress that can cause cracking and to ensure the viability of the seeds.
- Monitor the moisture content and stop the drying process at the desired MC. Too high moisture contents lead to qualitative losses and to discounted prices for wet paddy. Too low MC results in monetary losses because of unnecessary weight loss.

5 Dryer Components

A dryer typically consists of three main components and often has some additional accessories. The main components are: the drying bin for holding the grain; the fan for moving the air through the dryer and the grain; the air distribution system; and the heating system for pre-heating the drying air.

5.1 Drying bin

The function of the drying bin is to hold the grain for drying and in in-store drying also to serve as the storage bin after drying. Drying bins come in different shapes according to the requirements of the design of the dryer (Figure 12). Depending on the model of dryer and locally available materials they can be made from different materials such as metal, wood, concrete, bricks, woven bamboo mats etc.

5.2 Fan

Fans move the drying air through the drying system. Depending on the required airflow rate and the needed pressure creation either axial-flow or centrifugal fans are used. The differences of both fan types are as follows:

Table 5: Overview on axial flow and centrifugal fans

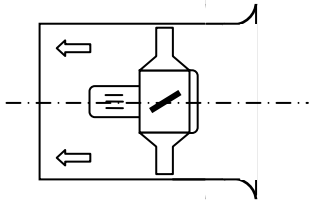
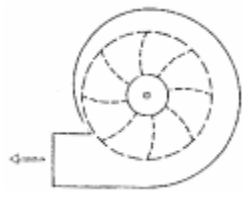
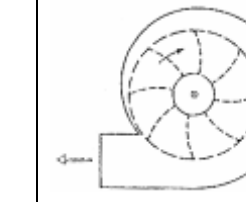
Fan type	Axial flow	Centrifugal, forwards curved	Centrifugal, backwards curved
			
Cost	Cheap	more expensive	most expensive
Characteristics ¹	non-overloading	overloading	Non-overloading
Pressure creation	10-15 cm water	0-15 cm water	0-30 cm water
Unstable region of operation	At high pressure	None	None
Construction	Sturdy	Light	Sturdy
Noise level	High	Low	Medium
Typical use	Aeration, recirculation batch dryer, batch dryer		In-store dryers

¹ Non overloading characteristics means that if the outlet of the fan is blocked the electric motor driving the fan will not overload.

Generally it can be said that the cheaper axial-flow fans provide a higher airflow rate at lower pressure creation and are therefore more suitable for shallow bed batch dryers with low resistance to airflow. They are also being used in re-circulating batch dryers where high air volumes are desired to remove water quickly for short drying time. The more expensive centrifugal fans have higher pressure creation and can

overcome the resistance of deeper beds but they have lower airflow rates. When a centrifugal fan is the choice backwards curved rotors should be used because of their non-overloading characteristics.

Fan design is an engineering art by itself and many fans sold by Asian manufacturers do not conform to their specifications. In tests conducted in the Philippines fan performance was 30-60% lower than quoted. On the other hand the fan is probably the most important component for getting good performance out of a dryer. When buying a fan it is therefore advisable to request the manufacturer to test the fan on a fan test rig in presence of the customer in order to guarantee that it performs according to the specifications.

5.3 Air Distribution System

The purpose of the air distribution system is to deliver the drying air to the drying zone in the dryer and to remove the moisture that was extracted from the grains. In suction systems they also collect the dust that is created after the air leaves the drying section. For fixed bed dryers usually positive pressure systems are used to blow the air through the grain bulk while re-circulating and continuous-flow dryers usually have negative pressure (suction) based air distribution systems.

Table 6: Comparison of pressure and suction based air distribution systems

	Pressure system	Suction system
Type of dryers	Fixed bed batch	Dryers with moving grain, re-circulating batch and continuous flow
Air tightness of bin	Fixed batch can be made airtight easily, large outlet	Moving mechanical parts make sealing difficult
Heater	Before fan	Before dryer inlet
Fan	High temperature resistance needed, sometimes exposed to flames	Lower temperature resistance
Dust	Stays mainly in fixed bed, set free when unloading	Sucked out with the drying air

Suction systems have the big advantage of collecting all the air that exits the dryer and thus also collecting the dust which can then be easily separated e.g. in a cyclone. This is getting more important with tighter emission control requirements. There are re-circulating dryers with pressure systems, especially when they have circular bins with radial airflow from inside-out because in this case the air outlet is much larger than the inlet. But these kind of dryers excessively release dust into the environment during operation.

Major elements of the air distribution system are a plenum chamber, air channels, and air ducts or false floors.

5.3.1 Plenum chamber

The plenum chamber is a chamber into which a fan delivers the drying air before it enters the grain bulk. The purpose of the plenum chamber is to let the air calm down before it enters the air distribution system in order to guarantee an equal distribution of pressure and temperature of the drying air throughout the drying section. The contribution of a properly designed plenum chamber to even drying and thus to producing good quality is often not known. The bigger the chamber is the more even the airflow will be. Generally speaking metal sheets are cheap and by providing for a sufficient plenum chamber is often a simple and cost effective way to improve drying air distribution.

5.3.2 Air ducts, false floors and air-sweep floors for fixed-bed drying bins

For fixed-bed batch dryers three different air distribution elements are used: air ducts; false floors; and air-sweep floors.

Table 7: Comparison of air ducts, perforated false floors and air-sweep floors

System	Air ducts	Perforated false floor	Air-sweep floor
Cost	Low	Medium	High (grill shaped metal plus fan)
Air distribution	Uneven	Optimal	Optimal
Requirements	Sealed floor Additional plenum chamber needed	Stable support structure needs withstand walking on it	Support structure Strong fan for conveying
Constraints	Manual unloading Uneven drying at high MC	Manual unloading	Dust creation

Air ducts are the cheapest solution for distributing the air in the grain bulk. Because of their uneven air distribution at the inlets they should only be used with low initial grain MC, e.g. for low-temperature drying in second stage dryers. Ducts are simple and easy to manufacture and they can be removed for unloading and cleaning the bin.

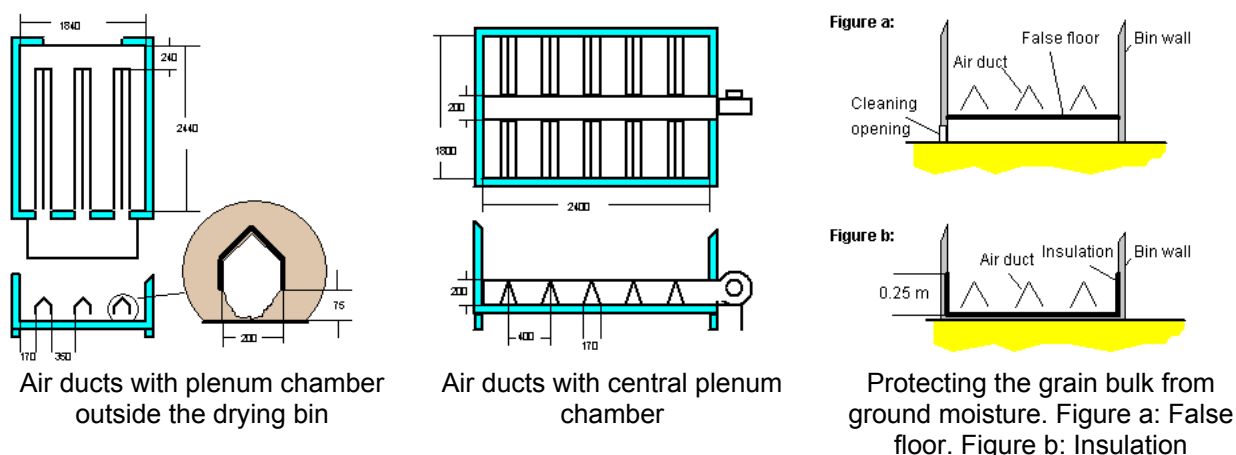

Figure 23: Examples for air duct configurations in fixed bed batch dryers for low-temperature drying

In batch dryers perforated false floors offer the most equal air distribution, which is important for high initial moisture contents. They are of simple design and are usually made of perforated metal sheet. The compartment underneath serves as plenum chamber. On the downside perforated metal sheets are more expensive than plain metal sheets that are used for air ducts. A strong support structure is needed for perforated metal sheets because during mixing and unloading laborers are often walking on the false floor.

The unloading of fixed-bed batch dryers can be mechanized by using air-sweep floors which, in combination with a strong fan, can convey the grain in the bin to an outlet opening. Air sweep floors are on principle perforated false floors but with grill shaped holes that give the air velocity a horizontal component. At low air speeds, when the floor is used for drying, the horizontal component of the air velocity is negligible. At higher air speeds, however, the air can convey individual grains horizontally. This effect is used for unloading after the initial grain flow by gravity has ended because the angle of repose of paddy was reached.

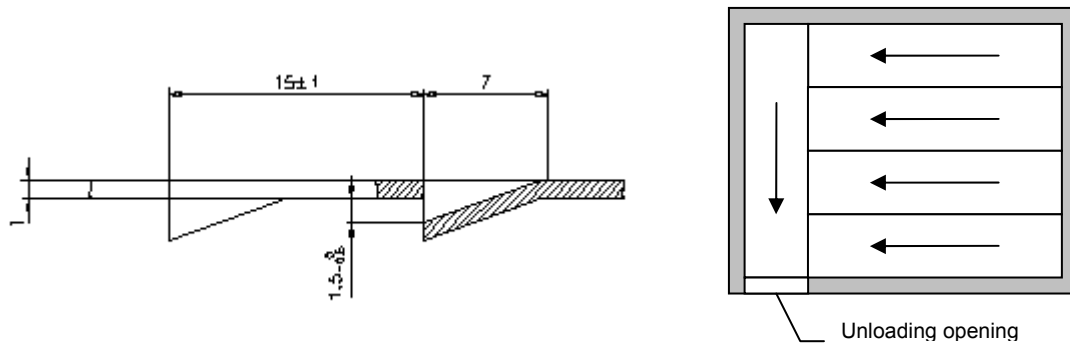

Figure 24: Cross-section through a perforated metal sheet used in air-sweep floors (left) and

For unloading the fan needs to be able to provide an airflow higher than that for drying. An additional fan can also be used. To reduce the capacity of the fan the floor of the drying bin can be equipped with air-sweep channels which can be operated alternately during unloading. In this case the air distribution is still better than with air ducts.

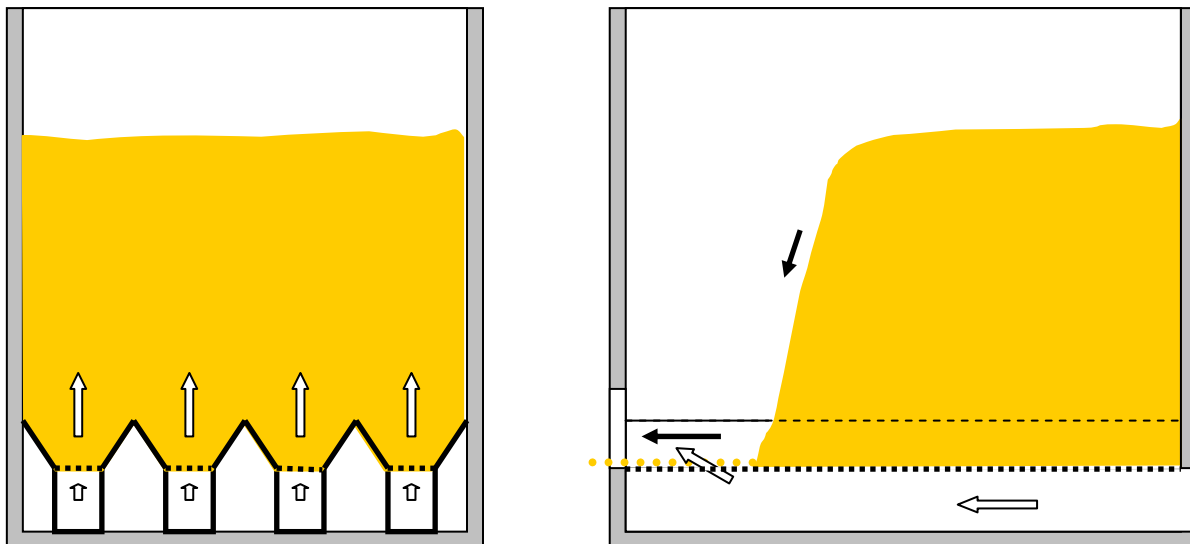

Figure 25: Cross section of a drying bin with 4 air-sweep channels (left) and through one channel while unloading (right)

The metal sheets for air sweep floors are more expensive than perforated sheet metal and they might not be available locally. The major drawback of air-sweep floors, however, is the excessive dust creation during unloading because the high velocity air effectively separates all dust contained in the grain bulk and blows it out of the drying bin.

5.3.3 Air ducts, general recommendations

The air distribution system should impose the least possible resistance to air-flow in order to provide sufficient drying air and to transport evaporated water away. For maximized airflow and even air distribution:

- Provide generous plenum chambers in pressure systems for even air distribution (metal is cheap,

fuel and quality loss is more expensive in the long run);

- At perforated false floors make sure that the open area (area of the holes) is at least 20% of the total area to avoid pressure drop at the perforated metal sheet. Use sheets with holes of around 2 mm to avoid clogging by fine particles and to prevent grains from falling through the holes;
- Make sure air ducts have sufficient size. It is better to over-design than to use too little diameters since turbulent flows in small diameter ducts waste a lot of energy;
- Prevent losses at junctions of ducts by using the same diameters;
- Make round curves instead of sharp edges when the airflow needs to change direction; and
- For inlets use nozzle shaped fittings instead of straight cut tubes.

5.4 Heating system

Depending on the availability and cost different fuels can be used for heating the drying air such as kerosene, diesel, LPG, biomass like rice hull, or electricity (Table 8).

Table 8: Overview on dryer heating systems using different fuels

	Kerosene/Diesel burner	Small Rice Hull Furnace	Automated Rice Hull Furnace	LPG burner	Electricity	Solar energy
Commercialization	High	Medium	Low	Few	None	None
Capital cost	Low	Medium	High	Medium	Low	High
Operating cost	Medium	Low	Low	Medium-High	High	None
Advantages	Easy handling of fuel Automatic operation High energy content	Cheap fuel CO2 neutral	Cheap fuel CO2 neutral	Easy handling of fuel Automatic operation Clean flame	Convenient Easy to control Clean	CO2 neutral
Constraints	Smell	Labor intensive Material difficult to convey Bulky fuel	High capital cost Wear of components. Bulky fuel	Availability Cost of fuel	Expensive Limited power load Highest energy form	Low heat generation

In Southeast Asia kerosene burners are most common because of their simple design, availability and easy handling of the fuel.



Figure 26: Kerosene burner attached at air heater of a re-circulating batch dryer

5.4.1 Rice hull furnaces

Rice hull is a by-product in rice milling and is usually available for free or are cheaper compared to fossil fuels. It is also a regenerative form of fuel and therefore from the environmental and economic point of view rice hull would be an ideal fuel for drying. Unfortunately the physical properties of rice hull like low density, abrasiveness, and steep angle of repose make it a product that is difficult to store, handle, convey and to gravity-feed it into furnaces.



Figure 27: A simple Vietnamese inclined grate rice hull furnace for a flat bed dryer with 6-8 t capacity

Available rice hull furnaces cover a wide range from simplest design where husk is piled on a grate (Figure 27) to highly sophisticated types with conveyors and control devices. Because simple designs are generally very labor intensive and the more complex designs require large investments and are prone to breakdown, rice hull furnaces are not widely used as heat sources for drying, except in the Mekong delta in Vietnam, where they have gained much popularity.

5.4.2 Direct and Indirect Heating

In direct heating the combustion products are mixed with the drying air meaning that they come in contact with the paddy. In western countries this is only allowed for products used to feed animals. In SE Asia direct fired heaters is not considered a problem because the flue gasses will only pollute the rice hull, which is not considered a problem since the hull is removed during the milling process. Indirect heating, on the other hand, involves a heat exchanger for heating up the drying air. It adds cost and decreases the total fuel efficiency of the dryer.

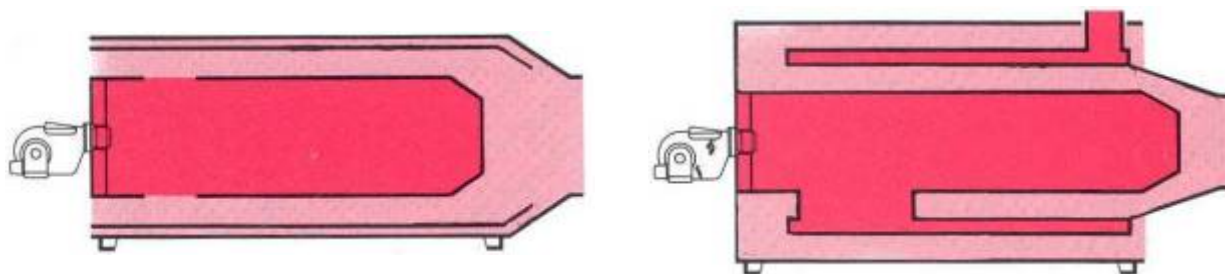

Figure 28: Direct fired (left) and indirect fired (right) air heaters, both with kerosene burner

5.4.3 Solar Drying

The use of solar energy as a heat source (solar drying, solar assisted drying) has been evaluated intensively by many projects and institutions. While some solutions were proven to be technically feasible none was successfully commercialized for paddy drying because of the following reasons:

- In natural convection dryers that were considered promising because they don't need a fan and thus no additional energy is needed the maximum layer depth of the grain is only 7 cm. Thicker layers provide too much resistance to the air that cannot be overcome by the small forces created by the thermal solar energy. The capacity of those dryers referred to the floor area they are using for the solar collector is far too small for any serious application;
- In solar tunnel dryers the drying air does not flow through the grain bulk but over the grain. The layer depth is therefore also limited to a few centimeters;
- Generally in solar dryers most heat is generated when it is not needed, at midday when the air RH is low anyway. Heating the air is needed at night when it rains or in early morning, when the RH of the ambient air is too high for drying. Some projects introduced additional devices to store the heat of the air during the day and release it when needed. This increases the capital cost beyond acceptable levels. The capacity is also limited;
- Solar collectors need to be made from durable materials (UV stabilized plastic), which makes them expensive. They consume a lot of floor area for a very limited heat accumulation. Feedback from the field indicated that cheap structures were often quickly destroyed by animals (e.g. village dogs), wind or solar radiation; and
- Generally capital cost per ton capacity is very high, which makes solar dryers suitable for high-value commodities that are dried in relatively small amounts (vanilla, spices, fruits, mushrooms, raisins etc.). Paddy is a high volume, low price commodity.

For above reasons solar drying is not recommended for paddy.

5.4.4 Safety Considerations

Since most dryers use air heaters that use various types of fuels they constitute a considerable safety risk.



Figure 29: Side wall of a re-circulating batch dryer that caught fire

For safe operation of the burner the dryer needs to be equipped with:

- A flame control to turn off fuel supply in case of ignition failure (automatic burners in re-circulating batch dryers).
- In gravity-fed pot-type burners a safety device that turns off fuel supply when there is a power failure that shuts off the fan.
- High temperature limit switch or temperature control to prevent overheating.
- Proper electrical wiring of all electric components.
- Proper ventilation of the outlets in pressure systems to prevent the accumulation of CO in the surroundings of the dryer.

6 Accessories for Grain Dryers

Depending on the grain dryer a number of accessories are necessary for proper operation. Therefore, it is often more appropriate to talk of a 'drying system' which, besides the dryer itself, contains the necessary accessories.

Paddy Pre-cleaner. As noted earlier, fines in rice create dust during the loading and drying process and reduce airflow through the rice grain. Pre-cleaners are indispensable in many drying systems. Pre-cleaners usually consist of a scalper that lets through the grain but retains straw and a smaller second screen that removes small stones and other impurities. An air aspirator will suck out dust and light empty grains.



Figure 30: A paddy pre-cleaner

Moisture meter. Keeping track of grain moisture content during drying is crucial to properly dry grain; that is, to avoid over drying or incomplete drying.

Over drying leads to monetary loss when selling the grain and to reduced milling yields due to cracking of the brittle dry grains.

Incomplete drying causes qualitative and quantitative losses from fungal growth, insect activity and respiration.



Figure 31: Commercial resistance type moisture meter

Conveyors and Elevator. Using conveyors and elevators for horizontal and vertical transport of grains will improve the efficiency of the drying operation and reduce labor costs. Elevators should be properly sized so that they match the capacity of the dryer. A properly designed bucket elevator for a re-circulating batch dryer can easily reach capacities of 10t/h.



Figure 32: Bucket elevators on re-circulating batch dryers

Dust collection system. Grain handling will create dust, making working around a grain drying hazardous. Efficient dust collection systems should be installed around the dryer to remove dust in and around the dryer. The conventional system for dust collection of grain is the cyclone. As with other accessories, fan and cyclone need to be properly sized depending on the dryer specifications.



Figure 33: Simple cyclone for dust collection

7 Drying Strategies

Paddy should be dried as quickly as possible but other considerations regarding the rice postproduction system and economic criteria have to be taken into account when developing a drying strategy. Options include de-centralized on-farm drying, centralized drying at collection points and two-stage drying also referred to as combination drying.

7.1 De-centralized On-farm Drying

Ideally the paddy needs to be dried on farm level immediately after harvest, which is mostly done through sun-drying, if the weather is favorable. For the production of better quality rice and the prevention of the weather risk farm level dryers can offer solutions, if certain criteria are met. This includes, among others:

- There must be a quality incentive, which allows producers to sell their machine dried paddy at a higher price and to use the machine even when sundrying is possible. If the dryer is only used to save the crop when it rains the dryer utilization will be very low and investment cannot be recovered. In that case users will practice sundrying whenever possible;
- Producers need to have the option to wait with selling their paddy until they can take advantage of seasonal price fluctuations; and
- Training and technical support services for need to be available and accessible to producers.

Farm level dryers are usually simple batch dryers made by local workshops from locally available materials. In practice only very few farmers use mechanical dryers because above criteria are usually not met.

7.2 Centralized drying

Economics of scale in drying can often only be reached through centralized dryers in a strategic location where enough paddy can be collected to be dried in a machine with sufficient capacity. Centralized drying can be done by farmers' cooperatives or small contract operators at village level, at local rice mills or at collection points in the trading system (mainly for second stage drying, see Chapter below). Owners of centralized dryers usually have better access than farmers to quality markets or they benefit directly from better quality of the dried rice, e.g. if the dryer is installed in a rice mill.

7.3 Two stage drying

Considering the theoretical drying curve of paddy (Figure 4) and the requirements for quick drying immediately after harvest to a MC that is safe for temporary storage the two-stage drying system or combination drying system was developed.

A typical first stage dryer takes advantage of the fact that surface moisture can be removed rapidly from very wet paddy without causing damage to the grains by using very high temperatures for a short period of time. Drying air temperatures in first stage dryers can reach over 100°C in fluidized bed dryers where the grain is exposed to the drying air only for a few minutes. After this rapid pre-drying to a MC of 18%, the grain is considered safe for up to two weeks of storage.

The grain is then transferred to a storage bin with aeration facilities where it is slowly dried to the desired moisture content of 14% or lower with only slightly pre-heated air or even ambient air if the climatic

conditions are feasible (see also Section 4.3).

Although two-stage drying has many advantages since it uses two different drying principles well suited to the different drying phases of paddy grains at different MC ranges the introduction of two stage drying in SE-Asia has so far failed. This strategy is used only in Thailand by the commercial sector.

Advantages:

- Decentralized drying to safe MC levels can be done close to the production in relatively small mobile pre-dryers extending the allowable time for handling. Final drying can be centralized in storage bins utilizing energy saving aeration.
- Low specific energy requirement since the two different drying technologies are optimized with respect to maximizing the drying potential of the drying air in the respective drying phases.
- The system can produce excellent quality since the last critical drying stage at low moisture contents is done with low temperature which prevents the kernel from cracking through heat stress or moisture adsorption.

Constraints:

- Users who want to dry from harvest to safe storage MC need two machines to complete the job.
- In-store drying only makes sense if the grain remains in the storage container for storage after drying. In most SE-Asian country bulk handling and storage is not yet practiced. If, in addition, there is a need to sell the paddy as quickly as possible after drying, as it is the case in most cases in SE-Asia, a dryer with shorter drying time is more appropriate.
- Economics of scale require a certain size of the in-store dryers. In farming environment with small scale farms where different varieties are grown often the necessary amount of the same variety for filling an in-store dryer cannot be collected.
- In countries where electricity cuts are part of daily life extended drying translates to increased risk. In this case a dryer with short drying time and ideally with self propelled fan and conveyors using a combustion engine reduces the risk of spoilage.

8 Economic Aspects of Drying

The use of mechanical drying systems offers so many advantages over sun drying like maintenance of paddy quality, safe drying during rain and at night, increased capacity, easy control of drying parameters and the potential for saving on labor cost that it is surprising that so few mechanical dryers are being used. Various studies have therefore focused on the factors that led to the failure of introduction of numerous drying systems. The constraints can be grouped under headers related to technology, know-how, post-production system, management and economics. Technology can be developed, know-how and management related issues can be addressed through capacity building measures, and post harvest system related problems can be taken care of by choosing the right technology options. However, with respect to economics drying faces a problem, which is unique for post-production operations, namely the availability of sun drying as a simple and very inexpensive alternative. In most cases pure economics therefore become the limiting factor for the introduction of mechanical drying systems.

This chapter does not elaborate in detail on how to conduct an economic assessment but points out some of the important considerations that have to be taken into account when doing a site-specific assessment on the potential of mechanical drying.

8.1 Potential Economic Benefits from Drying

Depending on the prevailing frame conditions and the postharvest system the use of mechanical dryers might provide the following economic benefits:

Figure 34: Overview on potential economic benefits from mechanical drying, pre-conditions for realizing those, and constraints

Economic Benefit	Pre-Condition	Constraints
Increased market value of the (higher quality) paddy	<ul style="list-style-type: none"> Existing and significant price differentiation for different quality levels, must compensate for drying cost plus weight reduction occurring during drying Market access 	<ul style="list-style-type: none"> Little differentiation of quality in the markets Little implementation of standards Quality markets still limited in volume Small batches of different varieties
Secured income from minimizing weather risk	<ul style="list-style-type: none"> Significant discount for spoiled or wet paddy 	<ul style="list-style-type: none"> Need to sell after harvest Discount would not cover drying cost
Increased income from being able to process more grain in a given time	<ul style="list-style-type: none"> Possibility of buying additional wet paddy 	<ul style="list-style-type: none"> Limited working capital

8.1 Weight Loss in Drying

During the drying process water is removed from the grains (see Section 3.1). That means that after drying there is fewer paddy to sell since in most markets paddy is traded on a weight basis. In markets, where paddy is still traded on a volume basis there is a similar effect since paddy shrinks in volume during drying also.

Example: 100 kg paddy with an initial MC of 28% are dried to 14%. The weight after drying is only 83.7 kg. This means that the person who does the drying needs to get around 20% higher price for the dried paddy in order to compensate for the loss in weight.

8.2 Cost of Drying

Studies conducted in Thailand and Cambodia [3] showed that the cost of drying in both countries is equivalent to 4% of the total paddy production cost. All the dryers that were successfully commercialized in Vietnam have drying cost with less than 5% of the paddy value [2]. Case studies in other Asian countries indicate that mechanical dryers with cost higher than 5% of the paddy value cannot be introduced successfully. There is no point in listing cost numbers for different drying systems here since drying cost depend in many site specific factors and a “business plan” including a cost-benefit calculation has to be conducted for each individual drying system considering the conditions of the locality.

Drying cost are composed of fixed cost consisting of depreciation, cost of interest, repair cost, and opportunity cost, and of variable costs consisting mainly of fuel, labor, and electricity costs. Depending on the purpose of the drying cost calculation drying cost can either be stated as annual cost or as cost per unit of weight. If the assessment is done to compare the dryer with other drying systems, e.g. with sundrying, the cost per unit of weight is more appropriate, if the drying system is evaluated as part of the whole postharvest system annual cost figures might be more feasible. In the following the cost is referred to one metric ton of dried paddy.

Total drying cost are composed of two components, fixed cost and variable cost.

$$C_D = C_F + C_V \quad [1]$$

Where:

C_D	=	Total drying cost
C_F	=	Fixed cost
C_V	=	Variable cost

To determine the drying cost three steps are necessary

1. Define realistic assumptions
2. Determine variable cost
3. Determine the fixed cost component

8.2.1 Assumptions

Defining realistic assumptions prove to be the most difficult part in the drying cost calculation because it requires a sound understanding of the postharvest system that the dryer is operating in.

Table 9: Example for general assumptions for drying cost calculations (based on Philippine data, 1994.)

Dryer service life:	5 years
Credit cycle:	5 years
Interest rate:	16 %
Capacity per batch:	5 tons
Drying time:	8 hours
Dryer utilization	60 days (batches) / year
Initial MC (wet basis):	26 %
Final MC (wet basis):	14 %
Weight after drying:	4.3 tons
Price for rice hull per 50kg:	\$0.54
Price per kWh:	\$0.13
Labor wage	\$4.17/day
Price difference between dry and wet paddy:	\$0.05/kg (dry season) \$0.06/kg (wet season)
Repair & maintenance for machines:	10 % of investment
Salvage value:	10% of Whole system cost
Labor requirement for loading & unloading:	1 man day / batch
Labor requirement for drying:	0.2 man days / batch

The assumptions are also often misused to “fine-tune” the drying cost calculation in order to come up with positive figures. The most critical assumption is the *machine utilization*, which is the major determinant in the fixed cost. Denying the fact that sundrying is a cheaper alternative to machine use usually is still practiced whenever the weather is favorable, too high figures for utilization are used resulting in low drying cost, which then cannot be reached in actual operation.

A properly done economic feasibility study should therefore include both sets of data. For the optimum and for more realistic utilization data based on existing practices in order to demonstrate to the users of the technology that they need to maximize its use in order to keep cost down.

8.2.2 Variable costs

The variable cost (or operating cost) consist of the cost items that only occur when the dryer is actually being operated, namely cost for labor, fuel, electricity and potentially some other minor cost items. Variable cost is often wrongly referred to as drying cost because these are the cost most obvious to the user.

$$C_{\text{var}} = C_{\text{fuel}} + C_{\text{electricity}} + C_{\text{labor}} + C_{\text{Vothers}} \quad [6]$$

Where:	C_{var}	=	Variable cost [\$/t]
	C_{fuel}	=	Fuel cost [\$/t]
	$C_{\text{electricity}}$	=	Electricity cost [\$/t]
	C_{labor}	=	Labor cost [\$/t]
	C_{Vothers}	=	Other operating cost [\$/t]

Cost of energy

For the fuels used in the air heater and in some cases for the engine that is driving the fan:

$$C_{fuel} = \frac{FC \cdot c_{fuel}}{m_{dry}} \quad [7]$$

Where:	C_{fuel}	=	Fuel cost [\$/t]
	FC	=	Fuel consumption [l/batch]
	c_{fuel}	=	Cost of one liter of fuel [\$/l]
	m_{dry}	=	Weight of dry grain per batch [t/batch]

For the electric components:

$$C_{electricity} = \frac{P \cdot lf \cdot t_{op} \cdot c_{kWh}}{m_{dry}} \quad [8]$$

Where:	$C_{electricity}$	=	Electricity cost [\$/t]
	P	=	Power rating of motor or component [kW]
	lf	=	Load factor (0..1, usually 0.7 for motors)
	t_{op}	=	Operating time of the component [h/batch]
	c_{kWh}	=	Cost of one kWh electricity [\$/kWh]
	m_{dry}	=	Weight of dry grain per batch [t/batch]

8.2.3 Fixed cost

The fixed cost consists mainly of investment costs for a system and depends highly on dryer capacity, state of technology and local content. The use of an existing structure, for example, can reduce installation costs significantly. Therefore the installation cost has to be determined for every target area.

$$C_{fix} = \frac{C_{depr} + C_{repair} + C_{interest} + C_{others}}{U} \quad [9]$$

Where:	C_{fix}	=	Fixed cost [\$/t]
	C_{depr}	=	Annual depreciation [\$/year]
	C_{repair}	=	Annual repair cost [\$/year]
	$C_{interest}$	=	Annual cost of interest [\$/year]
	C_{other}	=	Other annual cost [\$/year]
	U	=	Annual utilization [tons/year]

Depreciation

For simplicity a linear depreciation is used. Usually a salvage value is used in the calculation of the depreciation but in many cases this is not realistic since dryers typically are used in one location until they fall apart.

$$C_{depr} = \frac{C_{inv} + SV}{EL} \quad [10]$$

Where:	C_{depr}	=	Annual depreciation [\$]
	C_{inv}	=	Investment cost [\$]
	SV	=	Salvage value [\$]
	EL	=	Economic life [years]

Cost of repair

A certain budget needs to be allocated to maintenance and repair needs. Based on manufacturers' recommendations this can be expressed in percentage of investment.

$$C_{repair} = \frac{C_{inv} \cdot R_{repair}}{100} \quad [11]$$

Where:	C_{repair}	=	Annual repair cost [\$/year]
	C_{inv}	=	Investment cost [\$]
	R_{repair}	=	Rate of repair in % if investment cost [%]

Cost of interest

The cost of interest averaged over the years is:

$$C_{interest} = \frac{C_{inv} \cdot R_{interest}}{200} \quad [12]$$

Where:	$C_{interest}$	=	Annual cost of interest [\$/year]
	C_{inv}	=	Investment cost [\$]
	$R_{interest}$	=	Interest rate [%]

8.2.4 Other Economic Indicators

Break-even Point

The break-even point in batches per year can be calculated as follows:

$$BEP = \frac{C_F}{m_{dry} \cdot \Delta P - C_V} \quad [13]$$

Where:	BEP	=	Break-Even Point [batches/year]
	C_F	=	Fixed cost [\$]
	m_{dry}	=	Weight of grain per batch after drying [kg/batch]
	ΔP	=	Price difference of wet and dry grain [\$]

$$C_v = \text{Variable cost [$/year]}$$

Benefit-Cost Ratio

The benefit-cost ratio (BCR) is the ratio of the gross benefits divided by the initial investment costs plus the costs of operation. For an investment to be worthwhile, BCR should be greater than one to indicate that the investor is recovering every dollar's worth of his investment. Conversely, a BCR less than one implies that at the assumed interest rate, the investment being evaluated is not profitable. The benefit-cost ratio (BCR) is computed as:

$$BCR = \frac{B_{total}}{C_{total}} \quad [14]$$

Where:	BCR	=	Benefit-cost ratio
	B_{total}	=	Sum of discounted annual total benefit [\$]
	C_{total}	=	Sum of discounted annual total cost [\$]

8.3 Conclusions for Economic Feasibility Studies

Considering the issues in the last two Sections the following recommendations for economic analyses of mechanical drying can be made:

- Investing in a dryer for saving the crop will hardly lead to break-even. The problem is that in this case the fixed cost component of the drying cost (depreciation) per batch is very high because the dryer is only used in emergency, meaning a few times a year. A dryer used only in emergency cannot be used economically.
- Realistic data should be used for the annual dryer utilization considering alternatives like the option to sun dry during good weather.
- The price difference for wet and dry paddy needs to be sufficient to compensate for: the cost of drying; for the weight loss that occurs during drying; and to provide some profit for the operation.

9 Troubleshooting

This ChapterA drying system can only maintain quality but it cannot improve the quality of paddy. When a dryer produces poor quality paddy it is therefore important to compare the paddy from the dryer with a reference sample from the same batch that was dried under controlled conditions, e.g. in an air-conditioned room, or in the shade by spreading a thin layer and frequently mixing. Otherwise it is difficult to tell whether the low quality is caused by quality reduction that occurred before drying, e.g. during field drying, or in the drying system.

Figure 35: Problems with mechanical dryers, potential causes and possible solutions

Problem	Potential cause	Possible Solutions
Long drying time	Ineffective fan	Fan testing, replace fan
	Reduced airflow from turbulences or high resistance of air distribution system	Clean perforated sheets, bigger plenum chamber and air ducts,
	Low temperatures	Increase temperature within acceptable limits
Uneven drying	Too high air temperature in fixed bed dryers	Reduce air temperature, Mixing after initial drying
		Improve temperature control
High fuel consumption	Ineffective fan or air-distribution system	Improve air distribution system, use fan with higher efficiency
	Air-flow rates too high	Reduce air flow rate to normal levels (smaller fan)
Low germination rate	Too high drying air temperatures	Reduce air temperature
High number of broken grains	Moisture gradient, re-wetting after drying	Mix grain during drying in batch dryers
	Feeding of grain with different MC, re-wetting of dryer grain fractions	

10 References

- [1] Gummert, M., R. Aldas, I.R. Barredo, W. Muehlbauer and G.R. Quick (1993): Low-temperature in-store drying system. Project report, IRRI-GTZ Project Postharvest Technologies in the Humid Tropics.
- [2] Phan Hieu Hien (1998): Mechanical Dryer and Grain Quality in the Mekong Delta of Vietnam: History and Perspective of Development. Paper presented at the Conference on Science, Technology, and Environment for the Mekong Delta, Ca-Mau Province, Vietnam, 24-25 September 1998.
- [3] Konishi, Yasuo (2003): Towards a private sector-led growth strategy for Cambodia. Volume 1: Value Chain Analysis. Report prepared for The World Bank, Private Sector Development by Global Development Solutions, LLC.
- [4] Refalada-Lacson, H., R.D. Rigor, C.L. Ramos, and M.M. Bandong (1994): Communication Support Program on the Adoption of Alternatives to Highway Drying in Selected Towns of Nueva Ecija. NAPHIRE Technical Bulletin No. 16. National Postharvest Institute for Research and Extension, Nueva Ecija, Philippines.
- [5] Saponronnarit, Somchart, S. Prachayawarakorn and M. Wangji (1996): Progress in Commercialisation of Fluidised Bed Paddy Dryer.
- [6] Saponronnarit, Somchart (1996): Fluidised-bed paddy drying. In: Grain Drying in Asia. Proceedings of an international Conference held at the FAO Regional Office for Asia and the Pacific, Bangkok, Thailand, 17-20 October 1995, ACIAR Proceedings No. 71, p 201-209.

11 Appendices

Appendix 1: Testing of Grain Dryers

Appendix 1: Testing of Grain Dryers

After purchase or installment of a grain dryer it is important to evaluate its performance. This is usually done by conducting a drying test. Drying tests are important because actual performance data is often different from rated performance that is provided by the manufacturer. The following is a general procedure for evaluation of a grain dryer.

Drying Test

Paddy rice of a known source should be selected with grain MC that is typical for grain harvested in the area. The paddy should be cleaned so there are very few impurities (straws, etc) in it.

Before loading the material, mix the paddy and take at least 10 samples of the paddy of 10g each to determine variance in moisture content. In addition, sample 500g of wet paddy for laboratory analysis. If possible, take the entire weight of the paddy before loading.

Load the paddy and start the dryer. Measure the time that it took to load the dryer. Note the time that it takes to dry the paddy down to 14% MC. If possible, measure power consumption with a watt meter and measure fuel consumption with a flow meter. Alternatively, fuel consumption can be estimated by taking the initial weight or volume of the fuel and the final fuel weight after drying is completed.

During the drying process, measure drying air temperature with a thermometer at different locations in the dryer. After drying is completed, take the weight of the entire batch of dried grain. Also, take at least 10 samples of 10g for moisture content and one 500g sample for laboratory analysis.

Laboratory Analysis

Conduct a milling analysis of the pre-dried and post-dried sample that includes at least crack detection, milling yield, head rice recovery and discoloration.

Reporting

Calculate the following data to characterize the performance of the dryer:

1. Average and standard deviation of the moisture content before and after drying.
2. Total weight loss of paddy
3. Drying rate (%/h)
4. Increment in broken grain (i.e. percentage of broken grains before drying minus percentage of broken grains after drying)
5. Increment in cracked grain (i.e. percentage of cracked grains before drying minus percentage of cracked grains after drying)
6. Electric power consumption
7. Fuel consumption